

REV	DESCRIPTION	DATE	APPROVED
A0	CREATED DRAWING	2017/09/14	YMX

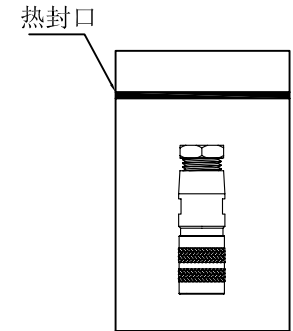
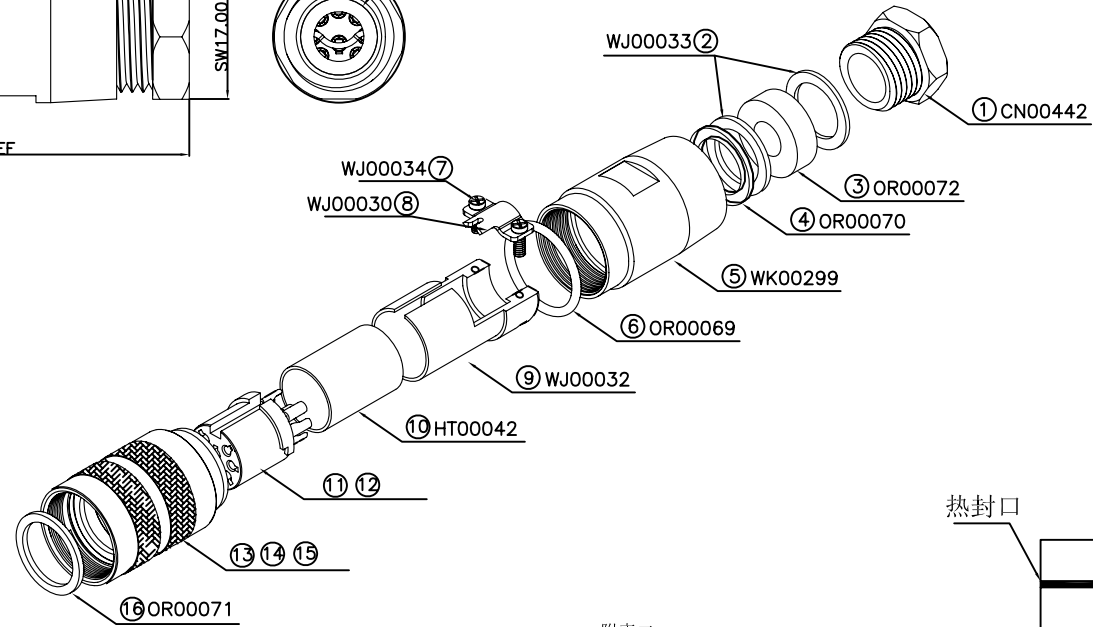
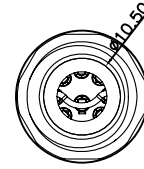
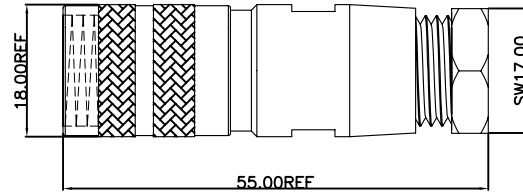
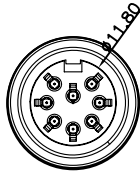

单PCS静电袋包装

注:

- 电气特性
 - 额定电压: 见附表一
 - 绝缘电阻: > 100MΩ
 - 额定电流: 附表一
 - 连接器的接触电阻 ≤ 5mΩ
- 机械特性: 插拔/周期 > 100 cycle
- 环境特性
 - 防护等级: IP67
 - 操作温度: -25°C ~ + 85°C
- 所有材料都符合RoHS标准。

附表一

PIN数	额定电压 AC/DC	额定电流
3PIN	250V	7A
4PIN	250V	6A
5PIN	250V	6A
6PIN	250V	5A
8PIN	60V	3A
7PIN(DIN)	60V	5A

附表二

SGN NO.	PIN数	①胶芯编号	②端子用量
160003-02-002	3PIN	CN00460	3PCS
160004-02-002	4PIN	CN00461	4PCS
160005-02-002	5PIN	CN00462	5PCS
160006-02-002	6PIN	CN00463	6PCS
160008-02-002	8PIN	CN00464	8PCS
160007-02-002	7PIN(DIN)	CN00518	7PCS

ITEM	PART NO.	SPECIFICATION	Q'TY	UNIT
16	OR00071	黑色硅橡胶防水胶圈φ14.8*φ11.8*1.5mm	1	PCS
15	WJ00029	M16 锌合金镀镍母主体φ16.2*21.8mm	1	PCS
14	WJ00031	M16 碳钢扣环φ16.8*1.0mm	1	PCS
13	WK00300	M16 黄铜镀镍外壳 φ19.0*22.35	1	PCS
12	TE00422	M16 2-8PIN 母端子镀金1u" 焊线式 φ1.5*L=17.3mm(YDTE0368)	见附表二	PCS
11	CN00XXX	见附表二	1	PCS
10	HT00042	透明PVC套管φ11.8*φ10.8*16.5mm	1	PCS
9	WJ00032	M16 锌合金镀镍 线槽主体φ16.2*21.8mm	1	PCS
8	WJ00030	M16 SPCC 镀镍线槽锁紧块12.2*8.35mm	1	PCS
7	WJ00034	M2*4.9 H1.2 OD=2.80mm 十字头	2	PCS
6	OR00069	黑色硅橡胶防水胶圈φ13.95*φ16.95*1.5mm	1	PCS
5	WK00299	M16 黄铜镀镍公母外壳φ18.0*26.9	1	PCS
4	OR00070	黑色硅橡胶防水胶圈φ10.0*φ13.8*0.8mm	1	PCS
3	OR00072	黑色硅橡胶防水胶圈φ13.6*φ7.15*4.5mm	1	PCS
2	WJ00033	M16 镀镍垫片φ13.8*0.80mm	2	PCS
1	CN00442	塑胶螺丝OD=10.5 L=13.4mm	1	PCS



SIGNAL®

Shenzhen Signal Electronics Co., LTD

TITLE M16 (3~8)P/F ASSEMBLY CONNECTOR

SGN NO 见表格

REV.

DWG NO

CUSTOMER

DRAWN BY

CHECKED BY

APPROVED BY

DATE

DATE

DATE

TOLERANCES ARE:

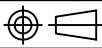
DECIMALES	ANGLES	THIRD ANGLE PROJECTION
.x ±0.5	x.' ±2.0'	
.xx ±0.20	.x' ±1.0'	

SCALE: A4 UNITS: mm SHEET: 1 OF 1

THE INFORMATION CONTAINED IN THIS DRAWING IS THE SOLE PROPERTY OF SIGNAL COMPANY. ANY REPRODUCTION IN PART OR WHOLE WITHOUT THE WRITTEN PERMISSION OF SIGNAL COMPANY IS PROHIBITED.